

FIRST[®] LEGO[®] League 2016 Model overview

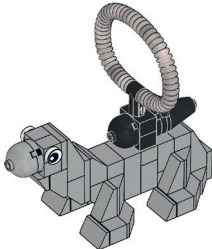

Coach Pins



Seal and Camera

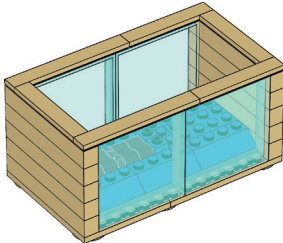

Tank

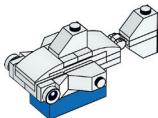

Shark

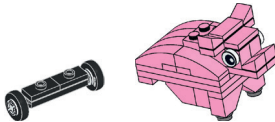

Our little friend

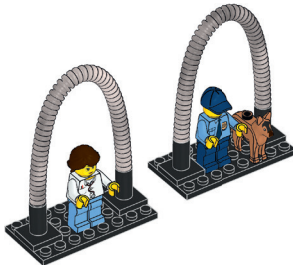

Zoologist, Dog and Trainer

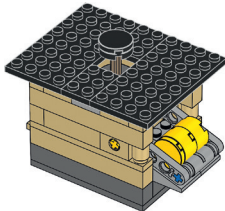

Beehive and Honey



Bee

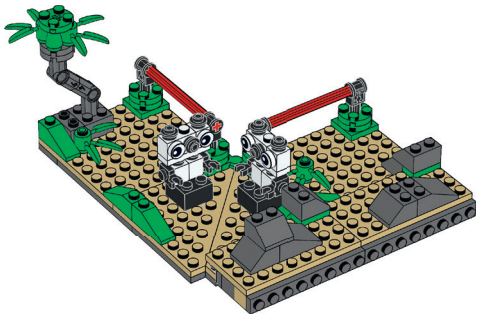

The Panda Observation and Return

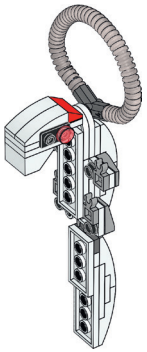

White Gecko

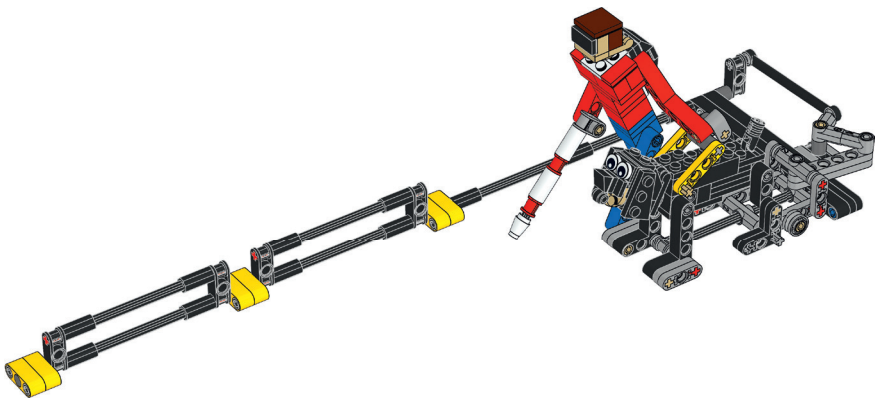

Service Dog and Man

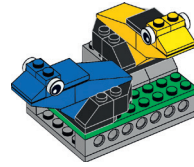

Frogs

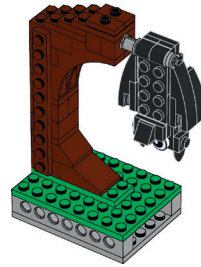

Bat

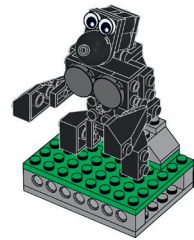

Gorilla

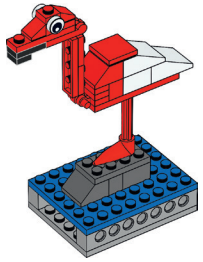

Flamingo

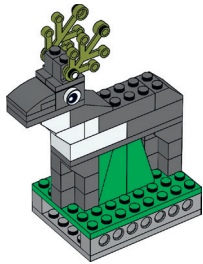

Reindeer

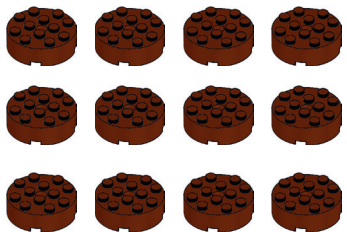

Manure Samples

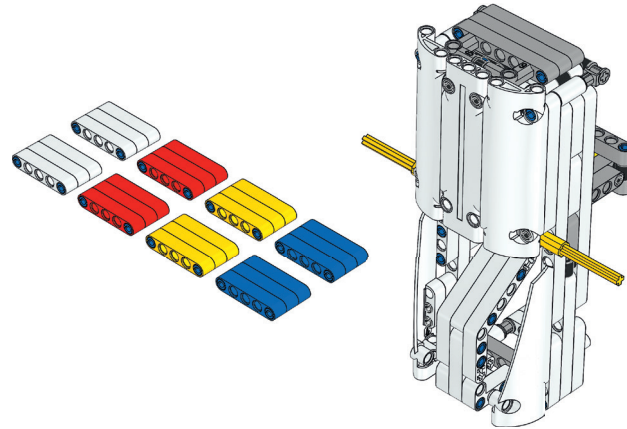

Food and Refrigerator

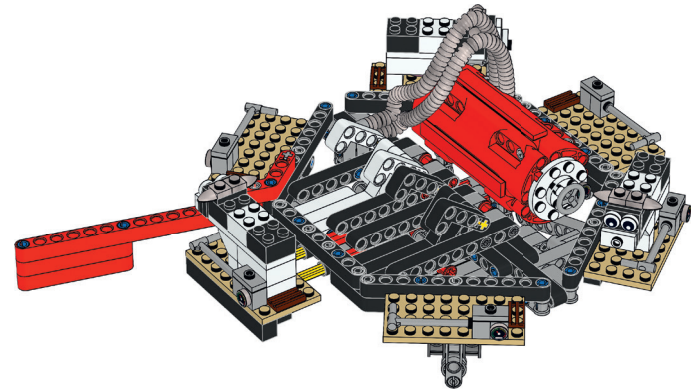

**Manure (Brown), Milk (white),
Milking Automation**

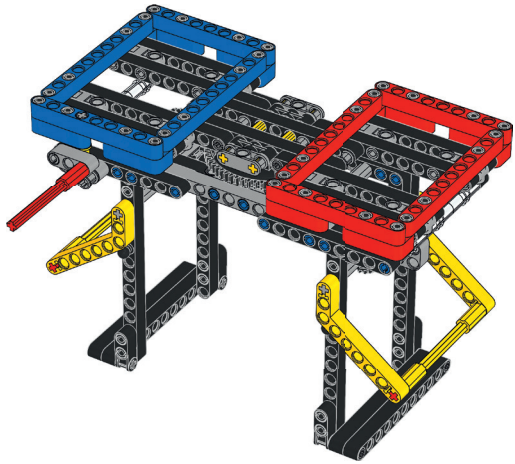

Animal Conservation



Biomimicry Wall and Green Gecko

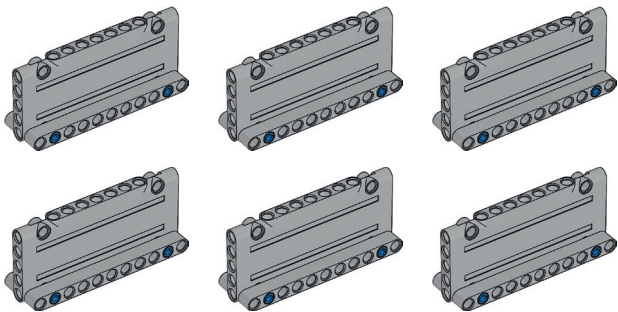

Barrier

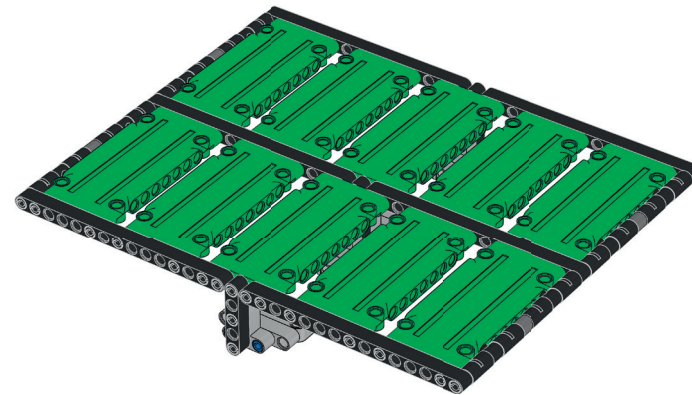

Ramp

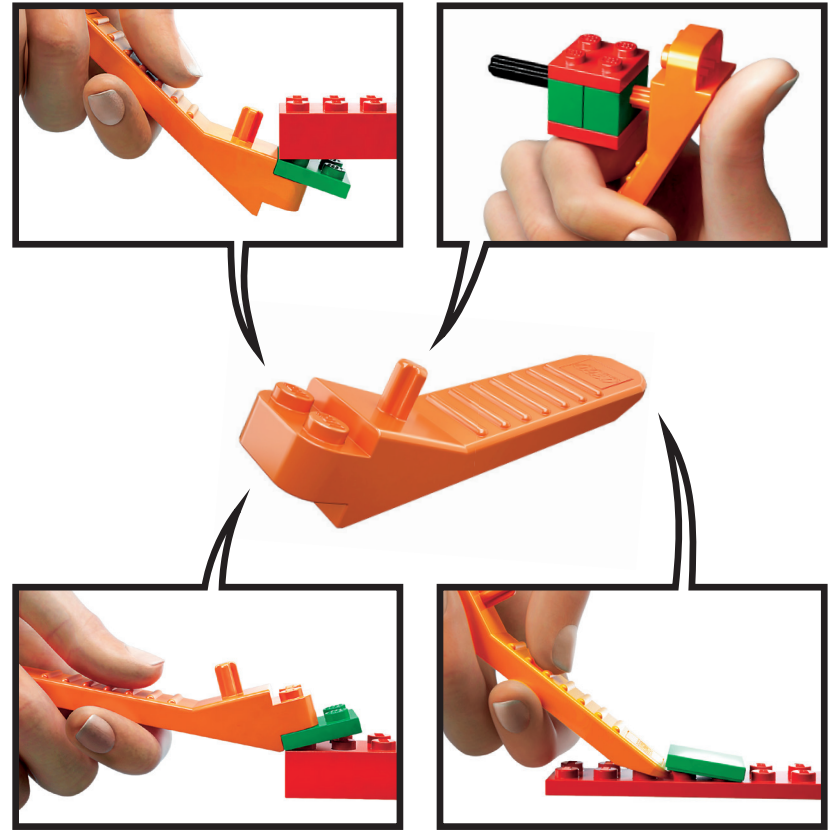

[LEGO.com/brickseparator](https://www.lego.com/brickseparator)

LEGO and the LEGO logo are trademarks of the/son des marques de commerce du/son marcas registradas de LEGO Group. ©2016 The LEGO Group.

FIRST® and the FIRST® logo are trademarks of the United States Foundation for Inspiration and Recognition of Science and Technology (FIRST®). FIRST® LEGO® League and ANIMAL ALLIES™ are jointly held trademarks of FIRST® and the LEGO Group. ©2016 FIRST and the LEGO Group.

FIRST® LEGO® League et ANIMAL ALLIES™ sont des marques déposées de FIRST® et du Groupe LEGO détenues en commun. FIRST® LEGO® League y ANIMAL ALLIES™ son marcas comerciales en propiedad conjunta de FIRST® y The LEGO Group.